



MADE IN ITALY

MINI PLUS

SCHEMA TECNICA



NUMERO DI GRADINI E ALTEZZA TOTALE (HT)

Mini Plus può coprire tutte le altezze, da quelle minime fino a quelle molto elevate. Qui sono riportate le altezze più frequenti con il numero di gradini necessari per raggiungerle. **Per maggiori informazioni 800 090 119**

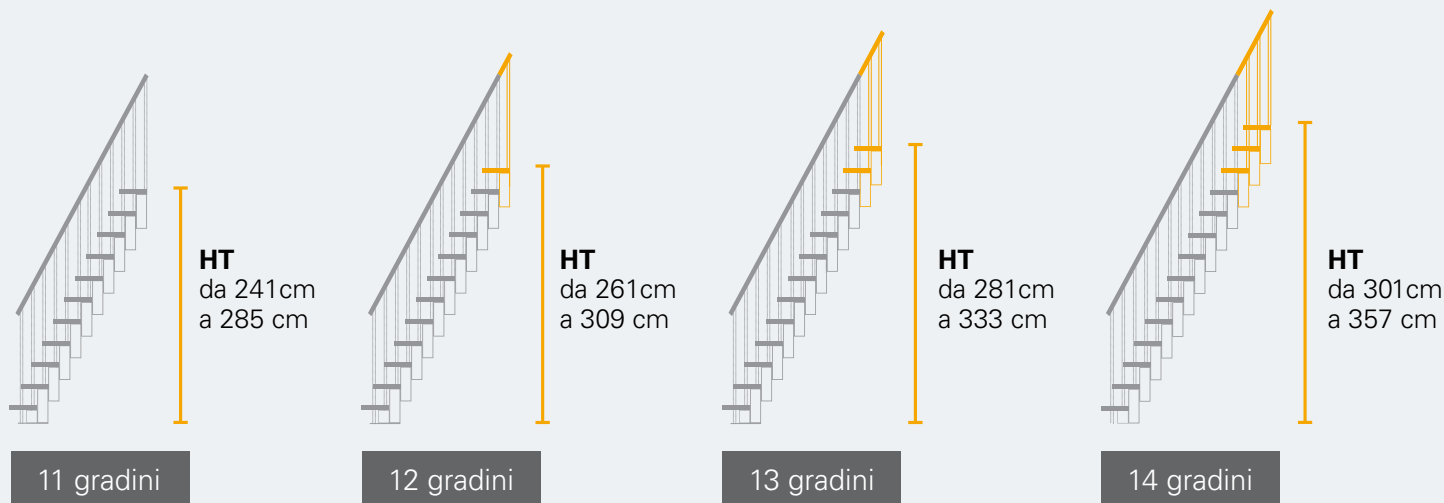

LARGHEZZA

(Compresa ringhiera)

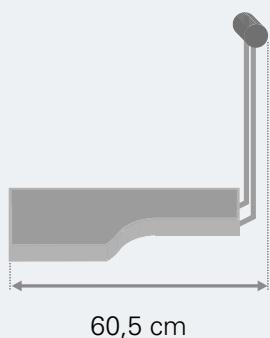

ALZATA REGOLABILE

(Altezza tra i gradini)

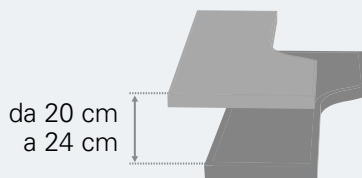

CONFIGURAZIONI

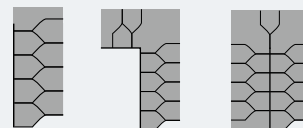

SENSO DI SALITA

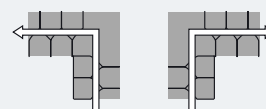

INGOMBRO A TERRA VERSIONE DRITTA A I

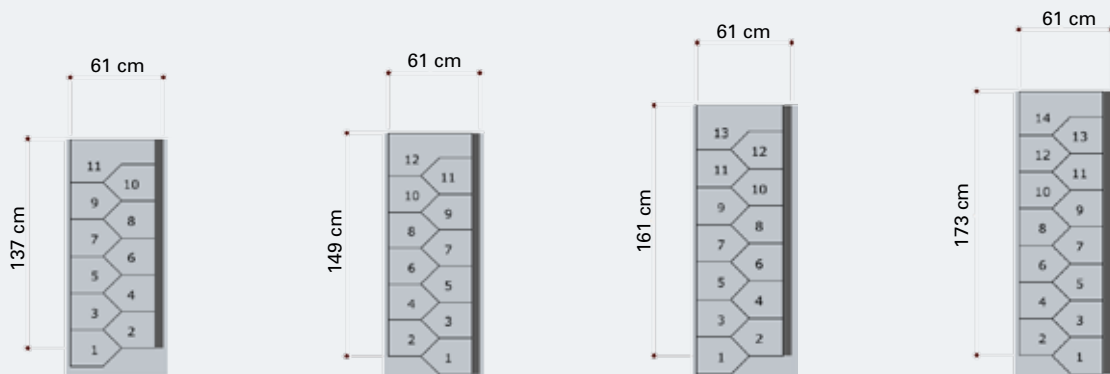

INGOMBRO A TERRA VERSIONE A L

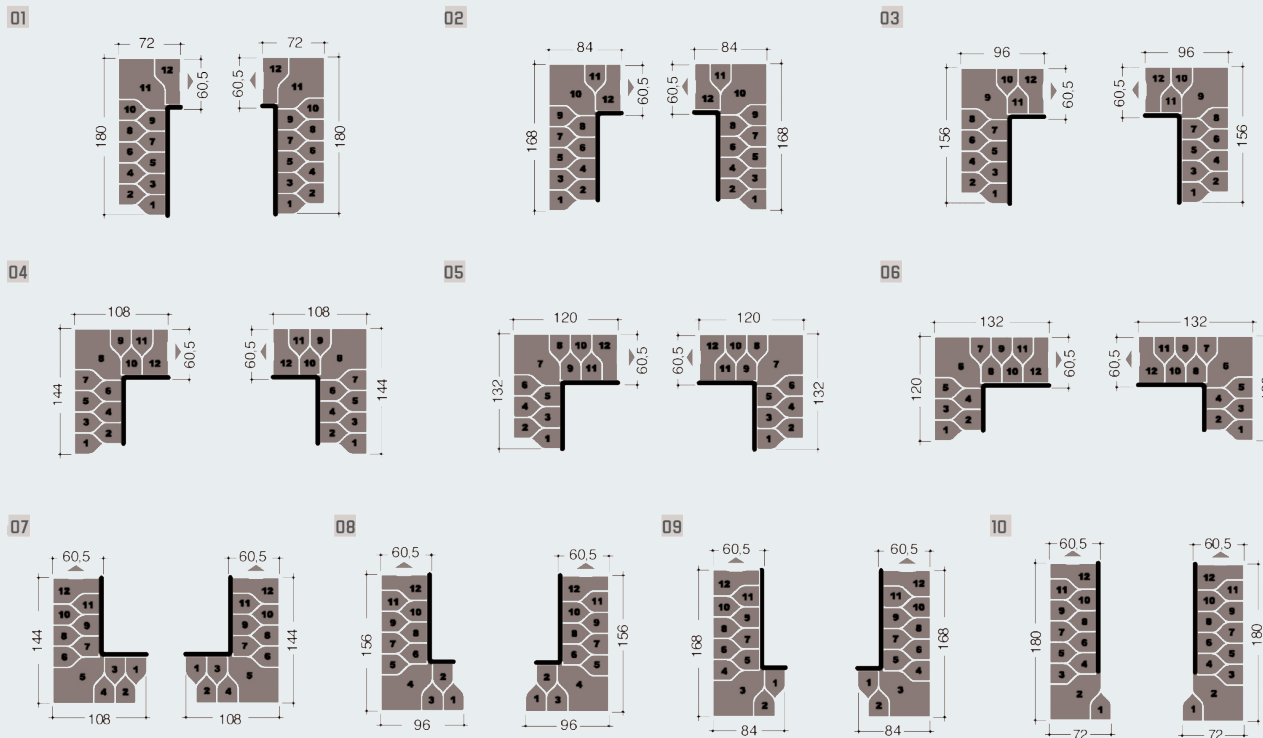

INGOMBRO A TERRA VERSIONE A U

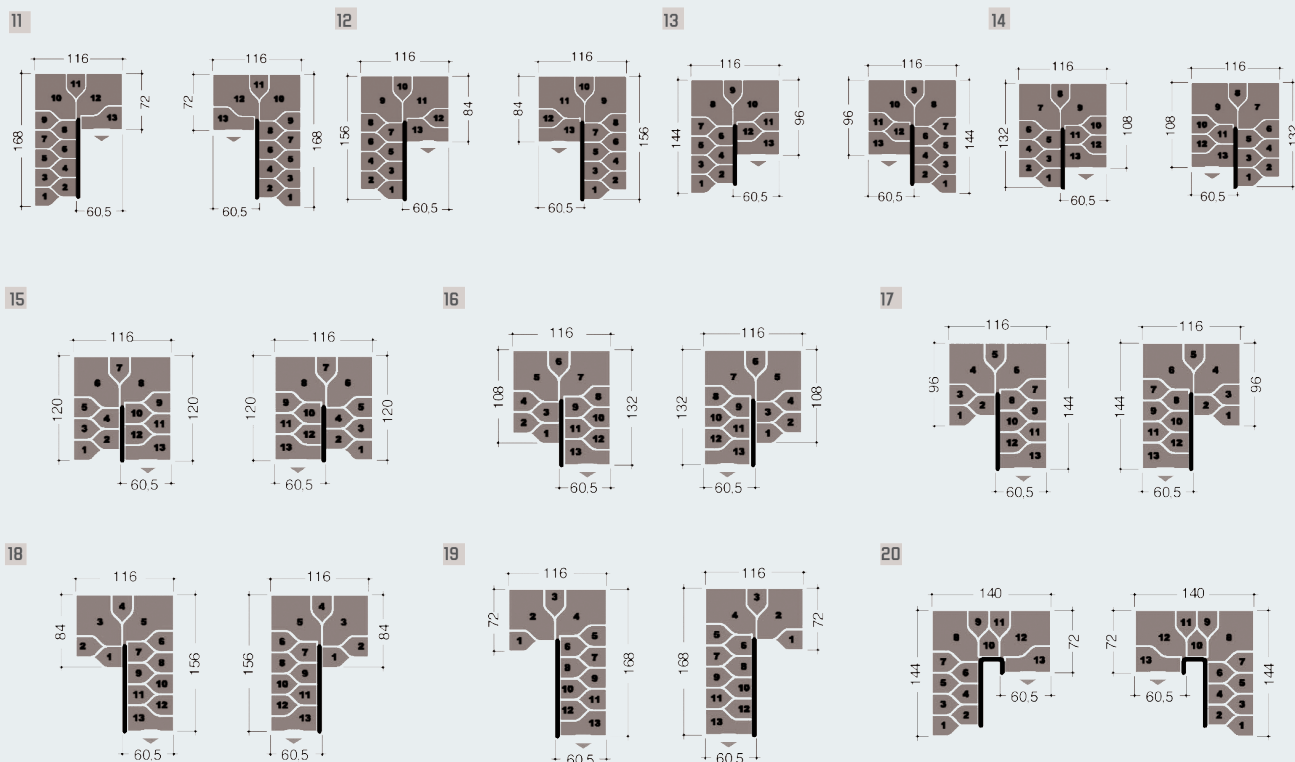

21

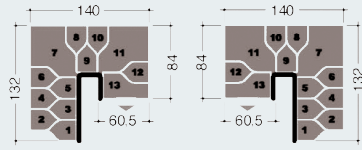

22

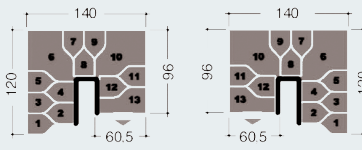

23

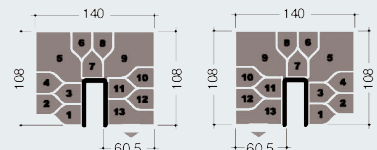

24

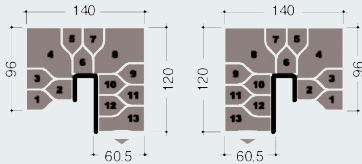

25

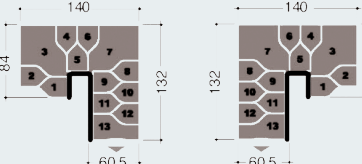

26

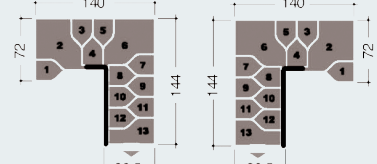

27

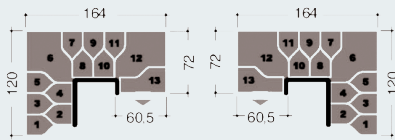

28

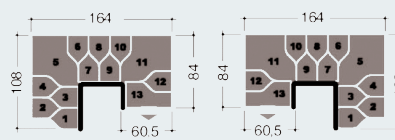

29

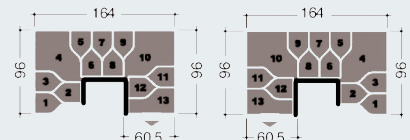

30

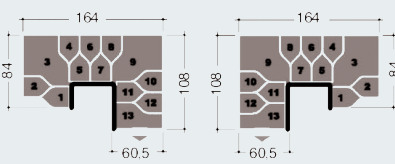

31

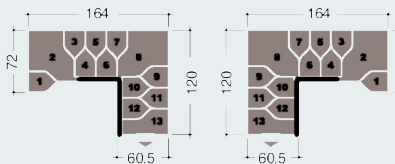

32

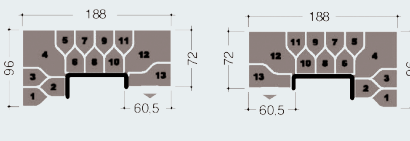

33

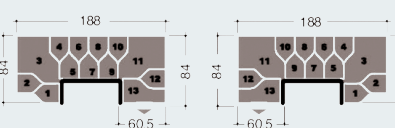

34

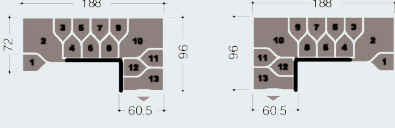

35

